

The Role of Calculus in Powering Technological Advancements

Angelaa Guptaa

Tanglin Trust School Singapore

DOI: 10.46609/IJSSER.2024.v09i07.025 URL: <https://doi.org/10.46609/IJSSER.2024.v09i07.025>

Received: 18 June 2024 / Accepted: 27 July 2024 / Published: 5 August 2024

ABSTRACT

The mathematical concept of differential and integral calculus has a range of applications in almost every aspect of our daily lives and is an essential part of complicated technology, spanning across from the business sector to the scientific world. Initially, the concept was used as a part of the mathematical protocol but as it deals with the rate of change the extent of application is exponential.

Keywords: Differentiation, Integration, rate of change, numerical algorithms, technological advancements, electromagnetism, optics.

Research question: Calculus as a concept has innumerable uses in the world. The role of this science with respect to technology has increased manifold. What are the reasons for this spread? Does this ancient mathematical concept develop over time to keep pace with the increasing demand for technology? What are the newer subdivisions of this science that have developed in recent years to make it relevant? These and other questions will be attempted during the paper.

Introduction

Technology is a recent introduction to the classroom teaching of mathematics. There has been increasing use of computer software programs along with graphing calculators, numerical algorithms, calculation, and modeling (Hansson, 2019). Not to mention, today mathematicians also use technology for proofs, validations, and counter-examples (Hansson, 2019). Unknown to most people, mathematics is the backbone of technological advancements, machine learning and data analysis heavily bank on mathematical models and statics (FINTECH Weekly, 2023). The compatibility of mathematics and calculus has generated maximum interest leading to a larger investment in the use of technology with an increased number of innovative approaches (Sevimli, 2016). At its core calculus deals with change and motion, making it indispensable in the field of computer science. By harnessing its power, we can build advanced systems that drive

modern technology (vidyapeeth , 2023).

Calculus is concerned with two matters: differentiation and integration and is a tool that is used by engineers in determining quantities as rates of change and areas (Fox and Bolton, 2002). This field is the backbone for dealing with variables changing with time or any other reference variable (Fox and Bolton, 2002). The use of rates of change allows the physical system to be represented, an analysis made and a solution formed under defined conditions (Fox and Bolton, 2002). This field is also used extensively in the study of electromagnetism; understanding the behavior of electric and magnetic fields. (geeksforgeeks, 2021) The range of applications in engineering includes designing structures, analyzing electrical circuits, and developing of new materials, it is also effective in predicting the behavior of physical systems under various conditions (geeksforgeeks, 2021). Another important use is in the structural analysis for seismic design requirements. Integral calculus is used to understand the geometry of a building, description of center of gravity as well as graphical representation (geeksforgeeks, 2021).

The manner in which calculus was integrated into technology along with its importance and examples of where the two interlink will be explored.

Figure 1: Importance of calculus

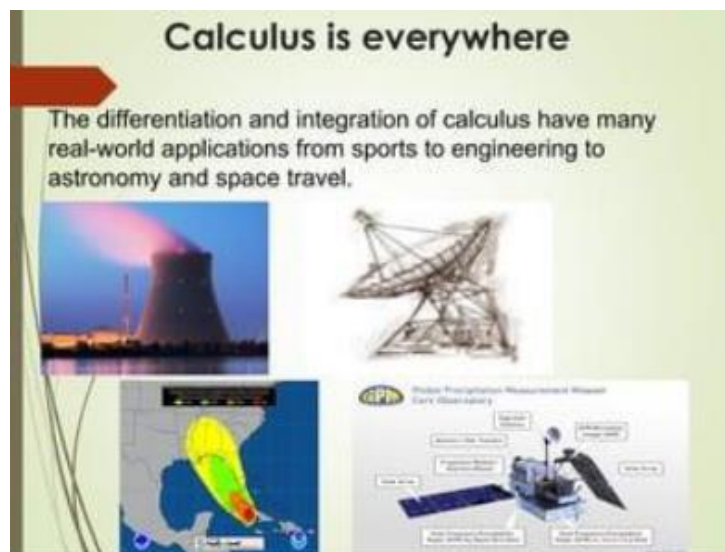

Source: (langove , 2019)

Definition:

Branches: differential calculus and integral calculus (Wikipedia Contributors, 2019). The former concerns instantons rates of change, and the slopes of curves, while the latter concerns the

accumulation of quantities and areas under or between curves the relationship between the two is what we call the Fundamental theorem of calculus (Wikipedia Contributors, 2019).

In differential calculus, the primary object of study is the derivative of a function, and the process of finding the derivative is called differentiation (Wikipedia, 2020). What differentiating does is it finds the gradient of a graph at a specific point, hence the rate of change of the graph about that point, this is equivalent to drawing a tangent about a point on a graph and then finding the gradient of the graph (Wikipedia, 2020).

Figure 2: Tangent about a point

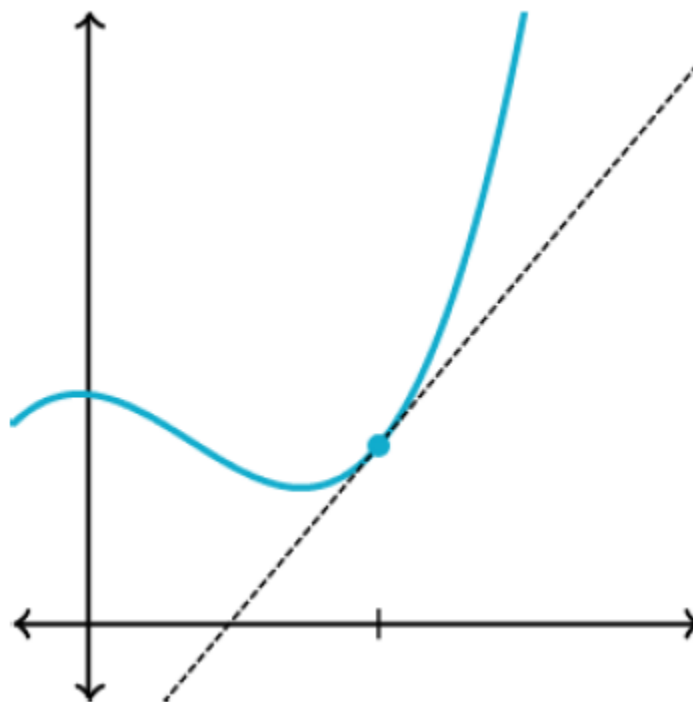

(Khan Academy , 2024)

The general differentiating power rule is as follows (Byjus, 2024).

$$\frac{dy}{dx} = nx^{n-1}$$

Within calculus different functions such as linear, exponent or reciprocal are differentiated differently, hence there are numerous formulas for differentiating. When there is more than one function in an equation, we use three rules: chain rule, product rule, and quotient rule (KhanAcademy , 2024).

The chain rule is used to express the derivative of the composition of two differentiable functions and has the equation as follows (Wikipedia, 2021).

$$\text{where } h(x) = f(g(x))$$

$$h'(x) = f'(g(x))g'(x)$$

The product rule is used to find the derivative of the product of two or more functions and has the equation as follows (Wikipedia Contributors, 2019b).

$$\frac{d}{dx}(u \cdot v) = \frac{du}{dx} \cdot v + u \cdot \frac{dv}{dx}$$

Finally, the quotient rule is used to find the derivative of a function that is the ration of two differentiable functions and has the equation as follows (Wikipedia, 2020b).

$$\text{where } h(x) = \frac{f(x)}{g(x)}$$

$$h'(x) = \frac{f'(x)g(x) - g'(x)f(x)}{(g(x))^2}$$

On the other hand, in integral calculus, we calculate the continuous analog of a sum, which is used to calculate areas, volumes, and their generalizations (Wikipedia Contributors, 2019b). The fundamental theorem of calculus relates definite integration (which is integration between two specific lines), to differentiation and provides a method to compute the definite integral of a function when its antiderivative is known; differentiation and integration are inverse operations (Wikipedia Contributors, 2019b).

The general power rule for integration is the opposite of the power rule for differentiation (Kumar, 2024).

$$\int x^n dx = \frac{x^{n+1}}{n+1} + c$$

Although integration can be used as an inverse operation of differentiation, its main use comes with finding the area under a curve; what happens is that the integration process is restricted to two points, and the area encompassed by the graph from those two points is what is derived which is definite integration (Byjus, 2024a).

Image 3: definite integration

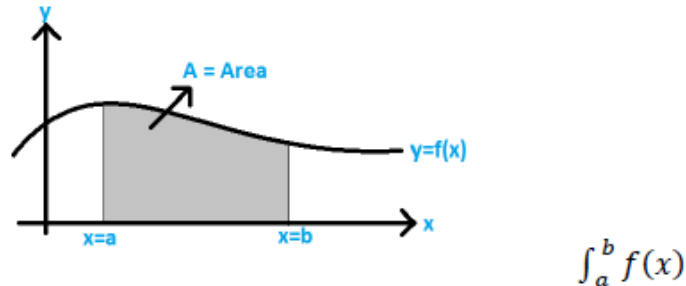

(Byjus, 2024a)

Calculus is highly important because not only can it give us the rate of change, and the turning points but can also be applied in other fields. For instance, in a displacement time graph, the equation of the first derivative gives us a velocity-time graph and the second derivative give us an acceleration-time graph whereas the integral of an acceleration-time graph gives us a velocity-time graph and so on (iitutor, 2020).

History and growth of calculus:

Originally called infinitesimal calculus or “the calculus of infinitesimals,” calculus was discovered in the late 17th century In Greece (Wikipedia Contributors, 2019). In the 1660s and 1670s Sir Issac Newton, an English mathematician and physicist, developed his ideas about calculus; he called his concept “fluxions” and was based on the concept of infinitesimals, that infinite is a tiny amount but not zero, which he applied to changes of motions problems and especially ones about planets (IBsuper, 2023). While trying to describe the speed of a falling object he found that the speed of the object increases every second and that there wasn’t an existing mathematical explanation for this, hence calculus was born (Oregon, 2019).

Image 4: Sir Isaac Newton

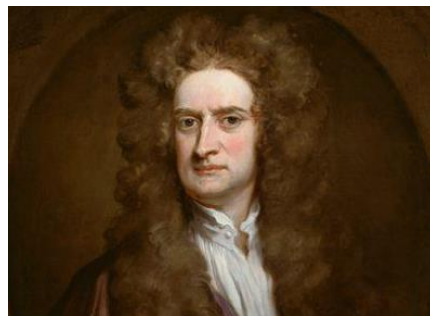

(Westfall, 2024)

At the same time, a German mathematician and philosopher, Gottfried Wilhelm Leibniz, had also developed calculus; however, she called his discovery “differential calculus” on the concept that the derivative is the measure of the rate of change of a function at a particular point which we now used today (IBsuper, 2023). What inspired Leibniz to discover calculus was his predecessor Johannes Kepler, who was the first human to accurately describe the motion of planets (Thomas, 2015). Kepler struggled to measure the rates of change of motion, which is necessary in astronomy, thus Leibniz created calculus (Thomas, 2015).

Image 5: Gottfried Wilhelm Leibniz



(Yvon Belaval and Look, 2018)

As they both discovered calculus simultaneously naturally, came conflict and controversy about who was the true creator. The dispute lasted for several decades and ultimately, they both were credited for their discoveries; however, Newton’s ideas were more widely accepted in England and Leibniz’s on the continent (IBsuper, 2023).

Although the creation is credited to both scientists Leibniz’s notation is what is used today (Wikipedia Contributors, 2019a).

Importance of calculus in technology:

The moment the field of computer science requires or indicates continuous change or optimization calculus is involved (Sharma, 2024). It is also used in analyzing the time and space complexity of algorithms (Alekhnovich et al., 2002), in optimizing a business process, engineering a new gadget, and predicting economic trends which is fundamental force for

innovation and efficiency in several fields (geeksforgeeks, 2024a). Calculus is the heart of mathematics and engineering as almost all applications of physics are based on the concept of calculus (geeksforgeeks, 2024a).

The use of differential calculus is similar to a super magnifying glass that allows the researcher to see how things are changing at that specific moment (geeksforgeeks, 2024a). It helps in understanding the concept of how fast or slow something is moving at any given point in time (geeksforgeeks, 2024a).

As differential calculus zooms in to look at any tiny piece of change, integral calculus adds up these tiny pieces in understanding the whole picture; Integral calculus looks at the total effect of changes over time or space (geeksforgeeks, 2024a). Calculus also allows understanding as well as playing around with things that change or move (geeksforgeeks, 2024a). Some of the core applications of the use of calculus are in;

Motion and change

Calculus helps us quantify how things move and change over time; from the way a rocket accelerates into space to the speed of a roller coaster (LibreTexts, 2019). This science provides the language to describe motion precisely.

In Optimizing processes calculus helps minimize costs by maximizing efficiency, which helps companies in deciding on the most efficient way to produce goods, or the quickest route for delivery (geeksforgeeks, 2024a). This science is used in fields like epidemiology that are crucial for modeling disease spread, preventive measures, and treatment strategies (geeksforgeeks, 2024a). It is also used in physics, especially in the field of motion and dynamics, electricity magnetism, and optics (concepts like the focal length of lenses and intensity pattern of light waves) (geeksforgeeks, 2024a). In economics, it is a pivotal tool for businesses to set prices and for governments to understand the impact of taxation on consumption (geeksforgeeks, 2024a).

The most beneficial area where this concept is used is in engineering; right from resigning bridges development of efficient batteries, calculus is used to calculate stress pressure and structural integrity It is used in statics and structures besides mechanics and dynamics, electrical Engineering, and thermal dynamics and Heat transfer (studysmarter, 2024). Applications in computer sciences are in the form of algorithm analysis, numerical methods, machine learning, data science, and computer graphics (BEZIER curve and B-splines) (Beaverton, 2022). In medicine it is used to optimize drug dosage and at the same time ensure minimum side effects, extremely important for critical treatment like chemotherapy (team, 2023). It is also used in audio engineering for tasks like filtering, equalization, and working with techniques like the Fourier transformation (geeksforgeeks, 2024a). Besides this it is involved in acoustics and sound

engineering, music composition and theory, music information retrieval, and audio compression (geeksforgeeks, 2024a).

Calculus in the corporate world

This helps business managers maximize their profits and measure the rate of increase in profit that results from each increase in production (Dawkins, 2024). It also helps in handling situations where deposits are flowing continuously into an account that earns interest (Dawkins, 2024). The moment the model is aligned to the flow of income in the form of a function, definite integrals is used to calculate the present and future value of a continuous income stream (Dawkins, 2024).

Credit cards

Intriguingly, credit card companies use calculus on certain aspects of your account ever month (Whatley, 2020). When minimum payments on a credit card need to be computed, differential calculus is used; this is due to there being so many changing variables to consider eg interest rates and available balances. Calculus allows these changing variables to be calculated simultaneously making it the perfect approach (Whatley, 2020). An example of the differential equation used is shown below (Whatley, 2020).

$$\text{accured interest} = \text{beginning balance} \times \frac{\text{(interest rate)}}{12}$$

The 12 here represents the number of months, and taking into account the interest rate. the minimum payment value is calculated which then establishes credit and after signing up with a credit card company becomes the customer's minimum monthly payment which has to be made on the card (Whatley, 2020).

Corporate planning

In business management similar to that in credit card payments there are various important factors which are constantly changing, which makes calculus highly beneficial in prediction; some examples are (geeksforgeeks, 2024);

- marginal analysis
- Optimization
- rate of change in understanding how different variables change over time

In corporate planning prediction is highly important because its helps in the decision- making

process and deciding on which action will lead to the most favorable outcome. As a result, the power of calculus is used in corporate planning due to its ability to analyze rates of change and create forecasts.

Designing - Complex shapes

Calculus helps in modeling complex shapes and surfaces; techniques like parametric equations and splines (a mathematical function defined piecewise by polynomials) use calculus to define curves and surfaces mathematically and allow designers to create smooth and intricate shapes, by applying calculus operations such as differentiation and integration (Knell, 2023).

Image 6: Splines

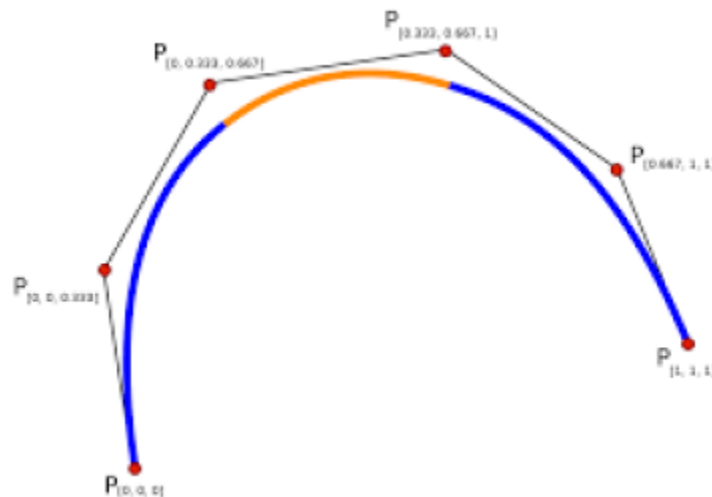

Source: (Wikipedia Contributors, 2024)

To add on, one of the most important concerns in architecture is the structural integrity of a building, which is where calculus comes in (team, 2024). Calculus enables engineers to analyze the forces acting on various structural elements, such as beams, columns, and trusses, and with differential calculus architects can model the behavior of these elements under different loads, allowing them to create a better complex shape of a building (team, 2024). Moreover, by using optimization in calculus architects can reduce the wastage of time of trial and error by being able to find their most efficient design (team, 2024).

Electronics

In electrical engineering calculus is extremely vital, it is used for describing changes in electrical quantities like voltage currents and energy (studysmarter, 2024a). Advanced machine learning

algorithms for example support vector machines are neural networks based on calculus principles (studysmarter, 2024a). It enables in formulation of loss functions and activation functions that are crucial in optimizing these models (studysmarter, 2024a). Calculus is considered as a corequisite in parallel with electrical engineering (studysmarter, 2024a).

Circuit analysis

In circuit analysis, there are electrical quantities that change over time, such as voltages, currents, and powers, which is where calculus comes into the picture (studysmarter, 2024). Calculus is used to accurately model and design electrical circuits, it's essential for understanding circuits that are time-independent, as they involve capacitors and inductors (studysmarter, 2024). Capacitors and inductors are electrical components that store energy supplied by a voltage source (Keim, 2020).

Image 7: a circuit consisting of a capacitor and inductor

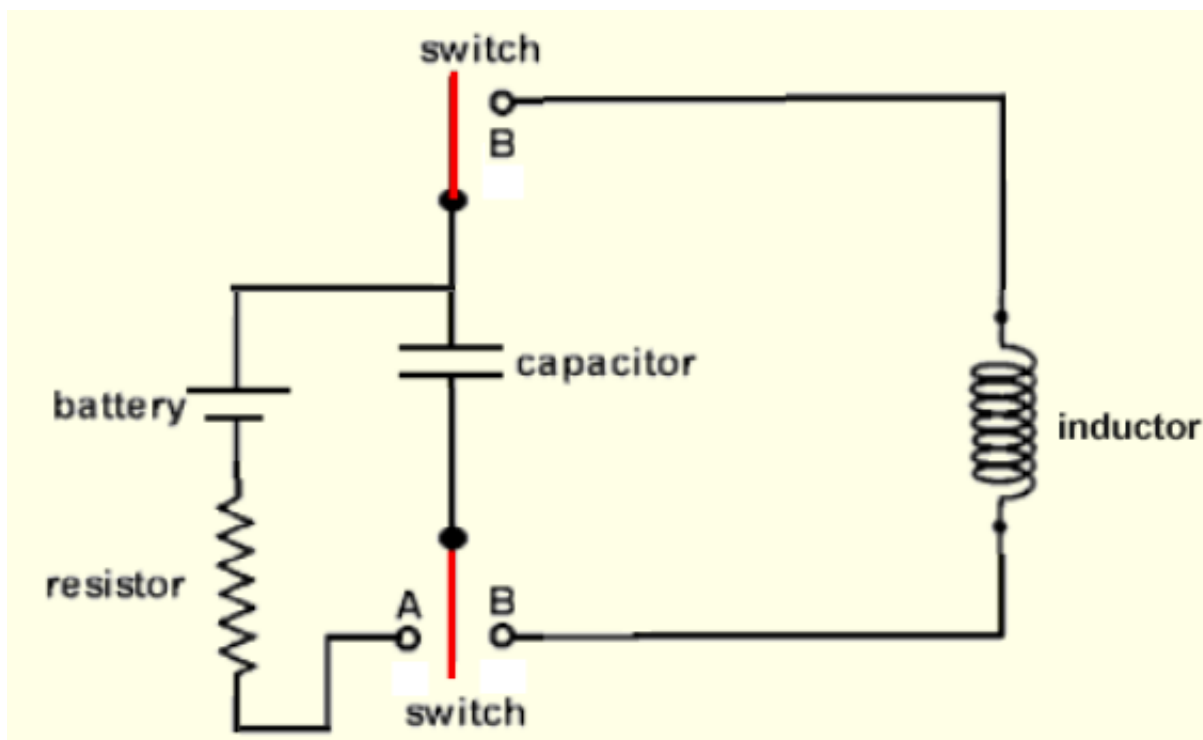

Source: (Colwell, 2024)

Engineers tend to represent electric circuits using mathematical equations which are functions of time, through differentiation and integration circuits are analyzed so that the current or voltage at any given time can be identified (studysmarter, 2024).

Signal processing

There has been an amazing growth in signal processing in various fields such as leading to image processing, the internet of things, communication or health diagnosis, and much more; recently researchers have used calculus to increase this growth further and give new life to modern signal processing (Meena, Lata and Meena, 2023). In a non-stationary signal, the signal measurements change over time, and calculus is used to accurately capture the measurements of these signals; In biomedical applications, however, calculus is used to solve biophysical problems and to describe the power dynamics of current flow and stress relationships (Meena, Lata and Meena, 2023). This shows the various ways calculus can be used within the same field and hence how vital is its role in our surrounding technological world.

Electromagnetisms

Vector calculus is a set of mathematical operations involving derivatives and integrals of vectors that can represent functions or fields in multiterminal space and is used intensively when dealing with electromagnetism (zurek, 2024). It allows engineers to gain information about the distribution of electromagnetic fields, energy associated with the field, electromagnetic radiation, and more (zurek, 2024). In the case of electrostatics, magnetostatics, or electrodynamics the behavior of electric and magnetic fields is defined through Max Well Heaviside's equations (wikipedia, 2024).

Image 8: Maxwell's equations

$$\begin{array}{l|l} \nabla \cdot \mathbf{D} = \rho_V & \nabla \cdot \mathbf{B} = 0 \\ \nabla \times \mathbf{E} = -\frac{\partial \mathbf{B}}{\partial t} & \nabla \times \mathbf{H} = \frac{\partial \mathbf{D}}{\partial t} + \mathbf{J} \end{array}$$

Source: (Byjus , 2024)

His equations included functions of time and position, which is where calculus comes in to help with analyzing the rates of change of certain variables (Wikipedia, 2024).

Control systems

Using the power of calculus researchers have found a way to better control systems; they have developed a new setpoint tracking strategy that improves the response time and stability of automated cars (Automation, 2016). By altering the design of a set point filter, a new, better filter was created which can not only suppress overshooting but also minimize the response time of a virtual controller through calculus (Automation, 2016).

In addition, calculus is also implemented in the control systems of aircraft, as their systems must be able to change conditions and objectives accurately (studysmarter, 2024). Differential equations provide the necessary frame to model and manage this dynamism (studysmarter, 2024).

Designing and regulating business of robots

Over the years researchers have started to use calculus more and more intensively across different fields; in the robotics field more specifically, calculus is used to provide a precise analysis of a robotic system (Bingi, 2024). In robotics, there is something called manifolds, which appear naturally as differential geometry and mathematical physics (Lybrand, 2020).

Image 9: the formal definition of manifolds

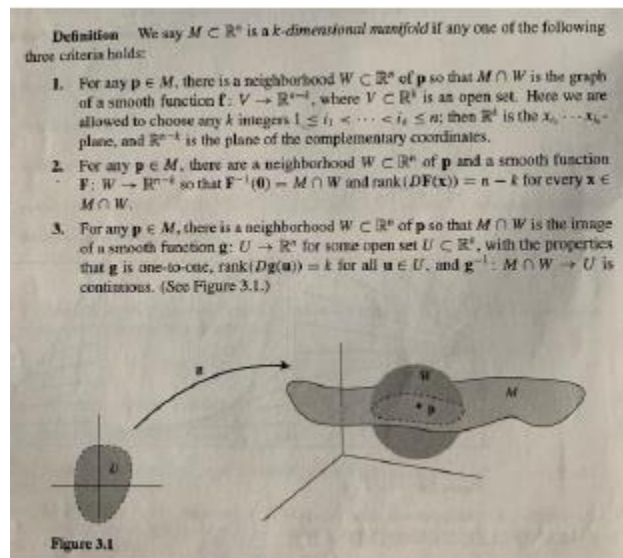

Source: (Lybrand, 2020).

One of the most basic uses of calculus in robotics is in motion where the linear acceleration and velocity, along with the angular acceleration and angular velocity provides the analysis of the

robotics motion (Jensen, 2019).

Conclusion

Calculus, both differential and integral, is one of the foremost mathematical concepts that have been adopted by technological experts to enhance their ability to provide scientific solutions in various areas. Calculus, which looks at the rate of change, is a theory that is required to understand how variables change over time. This is used most effectively in the fields of business, engineering, and the world of physics. Calculus being implemented so intensively in technology serves to prove its importance. It is a mathematical language used by physicists, economists, biologists, statisticians, and medical experts. Without it, the progression of technology would not only be slower but limited. When learned in lessons students tend to focus on it from an educational point of view but never as a whole in terms of its real-life applications. Most people use things in the real world which been created by the application of calculus, yet remain completely unaware of it. This is used in every application right from mundane things like how small droplets fill a water tank until reaching maximum volume to the complications of space exploration. Although not evidently visible calculus is vital and watching it interact with the real world is astonishing. A study of this concept enables a researcher to work in various fields and understand the importance of both differential and integral calculus.

Bibliography

Alekhnovich, M., Ben-Sasson, E., Razborov, A.A. and Wigderson, A. (2002). Space Complexity in Propositional Calculus. *SIAM Journal on Computing*,31(4),pp.1184–1211.
doi:<https://doi.org/10.1137/s0097539700366735>.

Automation, C.A. of (2016). *Fractional calculus helps control systems hit their mark*. [online] phys.org. Available at: https://phys.org/news/2016-12-fractional-calculus.html#google_vignette [Accessed 10 Jul. 2024].

Beaverton, S. (2022). *FIVE TYPES OF MATH USED IN COMPUTER SCIENCE*. [online] Mathnaisum. Available at: <https://www.mathnasium.com/math-centers/southbeaverton/news/five-types-of-math-used-in-computer-science-1101529702#:~:text=Calculus%20is%20the%20examination%20of,design%20and%20analysis%20of%20algorithms>.

Bingi, Dr.K. (2024). *Fractal and Fractional*. [online] www.mdpi.com. Available at: https://www.mdpi.com/journal/fractalfract/special_issues/fractional_order_calculus_in_robotics [Accessed 10 Jul. 2024].

Byjus (2024a). *Area Under the Curve Formula with Solved Example*. [online] BYJUS. Available at:

<https://byjus.com/area-under-the-curve-formula/#:~:text=The%20area%20under%20a%20curve>.

Byjus (2024b). *Differentiation Formulas | Derivative Formulas List*. [online] BYJUS. Available at: <https://byjus.com/maths/differentiation-formulas/>.

Byjus (2024). *Maxwell's Equations: Maxwell's 4 Equations And Their Derivations*. [online] BYJUS. Available at: <https://byjus.com/physics/maxwells-equations/>.

Colwell, C.H. (2024). *PhysicsLAB: LC Circuit*. [online] www.physicslab.org. Available at: https://www.physicslab.org/Document.aspx?doctype=3&filename=Induction_LCcircuits.xml [Accessed 10 Jul. 2024].

Dawkins, P. (2024). *Calculus I - Business Applications*. [online] tutorial.math.lamar.edu. Available at: <https://tutorial.math.lamar.edu/Classes/CalcI/BusinessApps.aspx>.

FINTECH weekly (2023). *Why Math Is Important in Today's Technologies - FinTech Weekly*. [online] FinTech Magazine Article. Available at: <https://www.fintechweekly.com/magazine/articles/why-math-is-important-in-today-s-technologies>.

Fox, H. and Bolton, B. (2002). *Calculus - an overview | ScienceDirect Topics*. [online] www.sciencedirect.com. Available at:

<https://www.sciencedirect.com/topics/mathematics/calculus>.

geeksforgeeks (2021). *Calculus in Maths - Formula, Definition, Types, Applications & more*. [online] GeeksforGeeks. Available at: <https://www.geeksforgeeks.org/math- calculus/>.

geeksforgeeks (2024a). *Application of Calculus: Real-life Uses*. [online] GeeksforGeeks. Available at: <https://www.geeksforgeeks.org/applications-of-calculus/>.

geeksforgeeks (2024b). *Real Life Application of Maths in Business and Management*. [online] GeeksforGeeks. Available at: <https://www.geeksforgeeks.org/real-life- application-of-maths-in-business-and-management/>.

Hansson, S.O. (2019). Technology and Mathematics. *Philosophy & Technology*, 33(1), pp.117–139. doi:<https://doi.org/10.1007/s13347-019-00348-9>.

IBsuper (2023). *The Interesting History Of Calculus: From Newton To Leibniz*. [online] IB Super. Available at: <https://www.ibsuper.com.sg/the-interesting-history-of-calculus- from-newton-to-leibniz/#:~:text=The%20roots%20of%20calculus%20can> [Accessed 2 Jul. 2024].

iitutor (2020). *Differentiation and Displacement, Velocity and Acceleration – iitutor*. [online] iitutor. Available at:

<https://iitutor.com/differentiation-and-displacement-velocity-and-acceleration/>.

Jensen , D. (2019). *What are some common applications of calculus in Robotics?* [online] Quora. Available at:

<https://www.quora.com/What-are-some-common-applications-of-calculus-in-Robotics#:~:text=In%20robotics%20specifically%3A> [Accessed 10 Jul. 2024].

Keim, R. (2020). *Capacitors and Capacitance vs. Inductors and Inductance - Video Tutorial*. [online] www.allaboutcircuits.com. Available at:

<https://www.allaboutcircuits.com/video-tutorials/inductance-and-capacitance/#:~:text=Capacitors%20and%20inductors%20are%20electronic>.

KhanAcademy (2024). *Finding tangent line equations using the formal definition of a limit (article) | Khan Academy*. [online] Khan Academy. Available at:

<https://www.khanacademy.org/math/ap-calculus-ab/ab-differentiation-1-new/ab-2-2/a/finding-tangent-line-equations>.

Knell , J. (2023). *Decoding the Equation: Does Coding Require Calculus?* [online] www.bloomtech.com. Available at: <https://www.bloomtech.com/article/does-coding-require-calculus#:~:text=Calculus%20helps%20in%20modeling%20complex> [Accessed 6 Jul. 2024].

kumar, U. (2024). *Integration Rules (Formulas and Solved Examples)*. [online] BYJUS. Available at: <https://byjus.com/maths/integration-rules/>.

langove (2019). *Application Of Calculus In Electrical Engineering*. [online] SlideShare. Available at:

<https://www.slideshare.net/slideshow/application-of-calculus-in-electrical-engineering/147518607> [Accessed 21 Jun. 2024].

LibreTexts (2019). *3.3: Using Calculus to Describe Motion*. [online] Physics LibreTexts. Available at:

[https://phys.libretexts.org/Bookshelves/University_Physics/Book%3A_Introductory_Physics_-_Building_Models_to_Describe_Our_World_\(Martin_Neary_Rinaldo_and_Woodman\)/03%3A_Describing_Motion_in_One_Dimension/3.03%3A_Using_Calculus_to_Describe_Motion](https://phys.libretexts.org/Bookshelves/University_Physics/Book%3A_Introductory_Physics_-_Building_Models_to_Describe_Our_World_(Martin_Neary_Rinaldo_and_Woodman)/03%3A_Describing_Motion_in_One_Dimension/3.03%3A_Using_Calculus_to_Describe_Motion).

Lybrand, E. (2020). *Robots & Calculus*. [online] elybrand.github.io. Available at:

<https://elybrand.github.io/robots/>.

Meena, S.C., Lata, P. and meena, M. (2023). *A Study of Signal Processing with Fractional*

Calculus. [online] European chemical bulletin . Available at:
<https://www.eurchembull.com/uploads/paper/0a71bb12177fa8cc44c92f3fd62c4504.pdf>.

Oregon (2019). *Isaac Newton's Work on Calculus – De analysi (1711)* /. [online] blogs.uoregon.edu. Available at: <https://blogs.uoregon.edu/scua/2019/02/04/isaac-newton-work-on-calculus-de-analysi-1711/#:~:text=His%20focus%20on%20gravity%20and>.

Sevimli, E. (2016). Do calculus students demand technology integration into learning environment? case of instructional differences. *International Journal of Educational Technology in Higher Education*, 13(1). doi:<https://doi.org/10.1186/s41239-016-0038-6>.

sharma, bhavya (2024). *The use of Calculus in Computer Science - bhavya sharma - Medium*. [online] Medium. Available at: <https://medium.com/@18bhavyasharma/the-use-of-calculus-in-computer-science-a6917dbe33b9#:~:text=What%20is%20the%20importance%20of> [Accessed 20 Jul. 2024].

studysmarter (2024). *Calculus in Engineering: Civil, Electrical, Mechanical | StudySmarter*. [online] StudySmarter UK. Available at:
<https://www.studysmarter.co.uk/explanations/engineering/engineering-mathematics/application-of-calculus-in-engineering/#:~:text=Application%20of%20Calculus%20in%20Electrical%20Engineerin&text=In%20circuit%20analysis%2C%20you%20frequently> [Accessed 10 Jul. 2024].

team, I.A.C. (2023). *Calculus in Medicine*. [online] iacedcalculus.com. Available at:
<https://iacedcalculus.com/applications-of-calculus-in-medicine/#:~:text=Calculus%20is%20essential%20for%20pharmacology>.

team, I.A.C. (2024). *The Applications of Calculus in Architecture*. [online] iacedcalculus.com. Available at: <https://iacedcalculus.com/the-applications-of-calculus-in-architecture/>.

Thomas, M. (2015). *How did Leibniz discover calculus?* [online] Quora. Available at:
<https://www.quora.com/How-did-Leibniz-discover-calculus>.

vidyapeeth , L. (2023). *Calculus in Computer Science: Where Math Fuels Technological Marvels!* [online] Lingaya's Vidyapeeth. Available at:
<https://www.lingayasvidyapeeth.edu.in/calculus-in-computer-science-where-math-fuels-technological-marvels/#:~:text=Calculus%20plays%20a%20vital%20role> [Accessed 20 June. 2024].

Westfall, R.S. (2024). Isaac Newton | Biography, Facts, Discoveries, Laws, & Inventions. In: *Encyclopaedia Britannica*. [online] Available at: <https://www.britannica.com/biography/Isaac->

Newton.

Whatley, T. (2020). *How Credit Card Companies Use Calculus* | Sapling.com. [online] Sapling.com. Available at: <https://www.sapling.com/4696774/credit-card-companies-use-calculus>.

Wikipedia (2021). *Chain rule*. [online] Wikipedia. Available at: https://en.wikipedia.org/wiki/Chain_rule.

wikipedia (2024). *Mathematical descriptions of the electromagnetic field*. [online] Wikipedia. Available at: https://en.wikipedia.org/wiki/Mathematical_descriptions_of_the_electromagnetic_field [Accessed 10 Jul. 2024].

Wikipedia (2020a). *Differential calculus*. [online] Wikipedia. Available at: https://en.wikipedia.org/wiki/Differential_calculus.

Wikipedia (2020b). *Quotient rule*. [online] Wikipedia. Available at: https://en.wikipedia.org/wiki/Quotient_rule.

Wikipedia Contributors (2019a). *Calculus*. [online] Wikipedia. Available at: <https://en.wikipedia.org/wiki/Calculus>.

Wikipedia Contributors (2019b). *Integral*. [online] Wikipedia. Available at: <https://en.wikipedia.org/wiki/Integral>.

Wikipedia Contributors (2019c). *Product rule*. [online] Wikipedia. Available at: https://en.wikipedia.org/wiki/Product_rule.

Wikipedia Contributors (2024). *Spline (mathematics)*. [online] Wikipedia. Available at: https://en.wikipedia.org/wiki/Spline_%28mathematics%29.

Yvon Belaval and Look, B.C. (2018). Gottfried Wilhelm Leibniz | Biography & Facts. In: *Encyclopædia Britannica*. [online] Available at: <https://www.britannica.com/biography/Gottfried-Wilhelm-Leibniz>.

zurek , stan (2024). *Vector calculus [Encyclopedia MagneticaTM]*. [online] www.e-magnetica.pl. Available at: https://www.e-magnetica.pl/doku.php/vector_calculus#:~:text=Vector%20calculus%20is%20used%20widely [Accessed 10 Jul. 2024].